

# JUST CONNECT

Compatible with AEG - AMPSHARE - BERNER - BOSCH - BOSCH GREEN - DEWALT - EINHELL - FEIN - FESTOOL - FLEX  
HAZET - HIKOKI - HILTI - INGERSOLL - MAKITA - METABO - MILWAUKEE - PANASONIC - RIDGID - SNAP-ON - WÜRTH



ONE LIGHTING SOLUTION  
FOR ALL BATTERY PACKS



2024

One lighting solution for all battery packs

# JUST CONNECT

Compatible with AEG - AMPSHARE - BERNER - BOSCH - BOSCH GREEN - DEWALT - EINHELL - FEIN - FESTOOL - FLEX  
HAZET - HIKOKI - HILTI - INGERSOLL - MAKITA - METABO - MILWAUKEE - PANASONIC - RIDGID - SNAP-ON - WÜRTH



With the new SCANGRIP CONNECT series, we have created a range of hybrid and innovative work lights compatible across all leading power tool brands - an outstanding lighting solution never seen before!

We connect the world of power tool batteries and professional work lights providing complete freedom to use a SCANGRIP work light regardless of your battery brand preference.

# SCANGRIP CONNECT product range



The CONNECT concept

04



NOVA CONNECT series

08



VEGA CONNECT series

12



AREA CONNECT series

14



MULTILIGHT CONNECT

18



BASIC CONNECT

22



DUO & TOWER COMPACT  
CONNECT

24



TOWER 5 CONNECT

26



STANDS and  
SUSPENSIONS

28



Technical specifications

30

**3**  
years  
warranty

PATENT PROTECTED

Designed by us. Manufactured by us.



# One lighting solution for all battery packs



// SCANGRIP is proud to present a complete range of outstanding and one-of-a-kind work lights compatible with all 18 V/20 V battery packs from leading power tool brands worldwide.

- Work lights compatible with 18 V/20 V battery packs from all leading power tool brands
- Smart connector with BATTERY SAFETY SYSTEM
- Extremely powerful illumination and high durability

## JUST CONNECT

One lighting solution for all 18 V/20 V battery packs with the SCANGRIP CONNECTOR



With the unique SCANGRIP CONNECT concept, you have complete freedom to choose the SCANGRIP work light that fits your needs regardless of brand preference.

A new invented smart CONNECTOR is designed for each power tool brand. Simply mount the CONNECTOR to the work light, attach your battery and you are ready to work. A BATTERY SAFETY SYSTEM protects the battery pack and makes it safe to use.

The SCANGRIP CONNECT range is designed for the demanding professional user and provides the latest COB LED technology, extremely flexible design and high durability. A ground-breaking lighting solution never seen before!



**NEW**

// Maximal freedom

The SCANGRIP CONNECT range is compatible with the METABO/CAS battery system\* and all other 18 V/20 V battery packs from leading power tools brands. As something unique, we also offer a POWER SUPPLY which can be used for direct power providing unlimited availability to light. With stands and suspensions available, the work lights can be placed anywhere you need efficient lighting offering complete flexibility at the worksite.

Use your 18 V/20 V battery pack for SCANGRIP CONNECT work lights



Convert your SCANGRIP CONNECT lamp to a corded model with the POWER SUPPLY



An integrated battery backup function prevents you from being without light at any time

(Applies to NOVA 4 CONNECT, NOVA 10 CONNECT and AREA 10 CONNECT)



\*Compatible with METABO / CAS battery system  
For METABO / CAS no connector is required

# SMART CONNECTOR

// SCANGRIP has developed a unique CONNECTOR for each individual power tool brand that fits 18 V/20 V battery packs. Simply mount the CONNECTOR to the work light, attach your battery and you are ready to work.

## BATTERY SAFETY SYSTEM

- Automatic discharge protection
- Overload protection
- Temperature surveillance
- Protected by design patent
- Approved by TÜV Rheinland



The BATTERY SAFETY SYSTEM protects the battery pack and makes it safe to use. The safety system features an automatic discharge protection, overload protection and temperature surveillance which means you can use your 18 V/20 V battery pack again and again without damaging it.

The SCANGRIP CONNECTORS are protected by design patent and approved by TÜV Rheinland. Each CONNECTOR is sold under separate item numbers and individually designed to fit each power tool brand.



Scan QR code to see TÜV Rheinland test report

**JUST CONNECT**

Add the connector matching your 18 V/20 V battery pack

ORIGINAL  
SCANGRIP



SINCE 1906

One lighting solution for all battery packs

# JUST CONNECT

Compatible with AEG - AMPSHARE - BERNER - BOSCH - BOSCH GREEN - DEWALT - EINHELL - FEIN - FESTOOL - FLEX  
HAZET - HIKOKI - HILTI - INGERSOLL - MAKITA - METABO - MILWAUKEE - PANASONIC - RIDGID - SNAP-ON - WÜRTH



Compatible with  
**METABO / CAS**  
battery system

SCANGRIP is part of the battery alliance METABO / CAS. The Cordless Alliance System (CAS) is a cross-manufacturer battery pack system of leading power tool brands using the powerful CAS battery pack system from METABO.

All SCANGRIP CONNECT products are fully compatible with METABO / CAS battery system without using the SCANGRIP CONNECTOR.



# NOVA 2 CONNECT - 2000 lumen handheld, compact floodlight

// Powerful compact and all-round work light designed for the professional user.

- Slim and compact design
- Extremely powerful illumination up to 2000 lumen
- Light dimmable in 5 steps
- Built-in powerbank

ORIGINAL  
SCANGRIP  
SINCE 1906



3  
years  
warranty

PATENT PROTECTED

BATTERY, CHARGER, CONNECTORS AND  
POWER SUPPLY ARE SOLD SEPARATELY

SCANGRIP CONNECTORS  
for 18 V/20 V battery pack



AEG - 03.6158C  
BERNER - 03.6155C  
BOSCH/AMPSHARE - 03.6140C  
BOSCH GREEN - 03.6141C  
DEWALT - 03.6142C  
EINHELL - 03.6143C  
FEIN - 03.6144C  
FESTOOL - 03.6153C  
FLEX - 03.6145C  
HAZET - 03.6146C  
HIKOKI - 03.6147C  
HILTI - 03.6157C  
INGERSOLL - 03.6152C  
MAKITA - 03.6148C  
MILWAUKEE - 03.6149C  
PANASONIC - 03.6156C  
RIDGID - 03.6154C  
SNAP-ON - 03.6151C  
WÜRTH - 03.6150C

Accessories

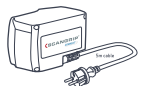

POWER SUPPLY  
03.6123C



CAS BATTERY  
18 V 5.2 Ah  
03.6121



CAS CHARGER  
03.6122

## // Portable work light

NOVA 2 CONNECT features the latest high-performance COB LED technology and provides up to 2000 lumen. The built-in light dimmer function makes it possible to adjust the light into five different steps according to the work task. It is also supplied with display for battery capacity and lumen output level.

NOVA 2 CONNECT is compatible with METABO / CAS battery system 18 V and all other 18 V/20 V battery packs from leading power tool brands by using the SCANGRIP CONNECTOR. In addition, the POWER SUPPLY can be used for direct power providing unlimited availability to light.

Due to the flexible stand and built-in hook, NOVA 2 CONNECT can be placed in different positions to obtain the desired lighting angle.

The housing is made of sturdy die-casted aluminum and resistant to strokes, shocks and vibrations. The durable construction makes NOVA 2 CONNECT perfect for the demanding, rough working environment.

As an extra feature, it has a built-in powerbank with USB outlet to charge mobile devices.

EU DESIGN  
PATENT  
213346



Light dimmable in 5 steps



### NOVA 2 CONNECT

€ 99.90

03.61.00C

Work light providing up to 2000 lumen

#### JUST CONNECT

Add the connector matching your 18 V/20 V battery pack



Use the SCANGRIP CONNECTOR to attach your 18 V/20 V battery pack to the NOVA 2 CONNECT lamp



Use the POWER SUPPLY for direct power



Hook for flexible positioning

# NOVA CONNECT - High efficiency and powerful COB LED floodlights

// The extremely sturdy NOVA CONNECT floodlights provide powerful illumination and feature BLUETOOTH light control for increased work efficiency.

- Powerful work lights up to 10000 lumen
- Integrated backup battery functionality
- Long operation time
- Extremely durable with high IP (IP65)
- BLUETOOTH light control app

ORIGINAL  
SCANGRIP  
SINCE 1906



BATTERY, CHARGER, CONNECTORS AND POWER SUPPLY ARE SOLD SEPARATELY

#### SCANGRIP CONNECTORS for 18 V/20 V battery pack



AEG - 03.6158C  
BERNER - 03.6155C  
BOSCH/AMPSHARE - 03.6140C  
BOSCH GREEN - 03.6141C  
DEWALT - 03.6142C  
EINHELL - 03.6143C  
FEIN - 03.6144C  
FESTOOL - 03.6153C  
FLEX - 03.6145C  
HAZET - 03.6146C  
HIKOKI - 03.6147C  
HILTI - 03.6157C  
INGERSOLL - 03.6152C  
MAKITA - 03.6148C  
MILWAUKEE - 03.6149C  
PANASONIC - 03.6156C  
RIDGID - 03.6154C  
SNAP-ON - 03.6151C  
WÜRTH - 03.6150C

#### Accessories

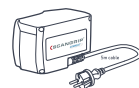

POWER SUPPLY  
03.6123C



CAS BATTERY  
18 V 5.2 Ah  
03.6121



CAS CHARGER  
03.6122

3  
years  
warranty

PATENT PROTECTED





Use the SCANGRIP CONNECTOR to attach your 18 V/20 V battery pack to the NOVA CONNECT lamp



Use the POWER SUPPLY for direct power

EU DESIGN PATENT 213346

## // Unlimited availability to light

The extremely powerful NOVA 4 CONNECT and NOVA 10 CONNECT provide up to 4000 lumen and 10000 lumen respectively, and are compatible with METABO/CAS battery system 18 V and all other 18 V/20 V battery packs from leading power tool brands by using the SCANGRIP CONNECTOR. In addition, the POWER SUPPLY can be used for direct power providing unlimited availability to light.

They are designed with a display for battery capacity and lumen output level, and supplied with a built-in powerbank. The work lights are also supplied with an integrated battery backup function securing you extra operating time to finish the job.

The NOVA CONNECT work lights are extremely sturdy and waterproof (IP65). The design is elegant, with a carrying handle and a stand for flexible positioning and direct mounting on the SCANGRIP TRIPOD.

## // BLUETOOTH light control

With the user-friendly BLUETOOTH light control app, you get an extraordinary possibility to turn on/off and control up to four work lights through a mobile device. The built-in dimmer function enables you to adjust the light output into five different levels. This feature saves time from manual operation and increases work efficiency on a daily basis.



### BLUETOOTH - Light control app

- Dimmer light output into 5 levels 10 % - 100 %
- Switch on/off, check battery
- Group control function, up to 4 lamps
- Assign pin code

Compliant with iPhone 5 or higher / Android 5.0 or higher. Go to iTunes App Store to download the app or download the app from scangrip.com



### NOVA 4 CONNECT

€ 189.90

03.6101C

Work light with BLUETOOTH providing up to 4000 lumen



### NOVA 10 CONNECT

€ 299.90

03.6102C

Work light with BLUETOOTH providing up to 10000 lumen



Convenient, built-in carrying handle



// Built-in powerbank

# VEGA CONNECT – Powerful and uniform LED floodlights



// The illumination of the VEGA CONNECT work lights provide a diffused and pleasant, non-blinding, uniform light with a large dispersion, perfect for any kind of work.

- Diffused, non-blinding light, up to 4000 lumen
- Portable due to compact design and low weight
- Made of a highly shock-resistant plastic material
- High IP54



## BATTERY, CHARGER, CONNECTORS AND POWER SUPPLY ARE SOLD SEPARATELY

### SCANGRIP CONNECTORS for 18 V/20 V battery pack



AEG - 03.6158C  
BERNER - 03.6155C  
BOSCH/AMPSHARE - 03.6140C  
BOSCH GREEN - 03.6141C  
DEWALT - 03.6142C  
EINHELL - 03.6143C  
FEIN - 03.6144C  
FESTOOL - 03.6153C  
FLEX - 03.6145C  
HAZET - 03.6146C  
HIKOKI - 03.6147C  
HILTI - 03.6157C  
INGERSOLL - 03.6152C  
MAKITA - 03.6148C  
MILWAUKEE - 03.6149C  
PANASONIC - 03.6156C  
RIDGID - 03.6154C  
SNAP-ON - 03.6151C  
WÜRTH - 03.6150C

### Accessories

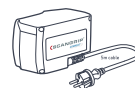

POWER SUPPLY  
03.6123C



CAS BATTERY  
18 V 5.2 Ah  
03.6121



CAS CHARGER  
03.6122

3  
years  
warranty

PATENT PROTECTED

## // Powerful, diffused LED light

The powerful VEGA 2 CONNECT and VEGA 4 CONNECT provide up to 2000 lumen and 4000 lumen respectively. The powerful LEDs provide a diffused and pleasant, non-blinding uniform work light, with a large dispersion, perfect for painting and installation work. It features 2 level light output (50 % - 100 %) which makes it possible to adjust the light according to the work task.

The floodlights are compatible with METABO/CAS battery system 18 V and all other 18 V/20 V battery packs from leading power tool brands by using the SCANGRIP CONNECTOR. In addition, the POWER SUPPLY can be used for direct power providing unlimited availability to light.

## // High flexibility and durability

The VEGA CONNECT floodlights come with an integrated carrying handle and a stand for tripod mounting which make it very convenient and easy to position the light where it is needed.

The robust housing is made of a highly shock-resistant plastic material, perfect for a working environment. It is also waterproof (IP54). Since the LEDs do not produce heat, there is no fire hazard when using the floodlight.

EU DESIGN  
PATENT  
213346

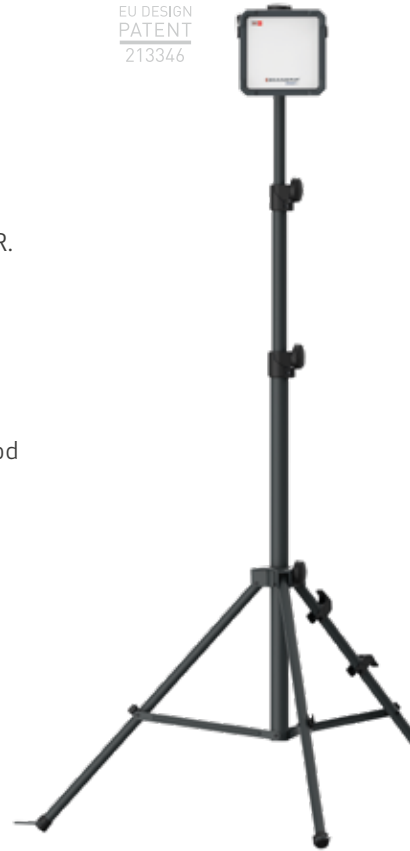

### VEGA 2 CONNECT

€ 84.90

03.6106C

Floodlight providing  
up to 2000 lumen



### VEGA 4 CONNECT

€ 134.90

03.6104C

Floodlight providing  
up to 4000 lumen



Use the SCANGRIP CONNECTOR to attach your 18 V/20 V battery pack to the VEGA CONNECT lamp

Use the POWER SUPPLY for direct power



# AREA 10 CONNECT – 10000 lumen high efficiency 360° work light



// Compact and portable area work light with many applications. Providing a diffused and uniform light, it is ideal for the professional user who requires powerful and efficient illumination of the entire worksite.



- Diffused, non-blinding light, up to 10000 lumen
- Portable due to compact design and low weight
- High IP65
- BLUETOOTH light control app



**BATTERY, CHARGER, CONNECTORS AND POWER SUPPLY ARE SOLD SEPARATELY**

#### SCANGRIP CONNECTORS for 18 V/20 V battery pack



- AEG - 03.6158C
- BERNER - 03.6155C
- BOSCH/AMPSHARE - 03.6140C
- BOSCH GREEN - 03.6141C
- DEWALT - 03.6142C
- EINHELL - 03.6143C
- FEIN - 03.6144C
- FESTOOL - 03.6153C
- FLEX - 03.6145C
- HAZET - 03.6146C
- HIKOKI - 03.6147C
- HILTI - 03.6157C
- INGERSOLL - 03.6152C
- MAKITA - 03.6148C
- MILWAUKEE - 03.6149C
- PANASONIC - 03.6156C
- RIDGID - 03.6154C
- SNAP-ON - 03.6151C
- WÜRTH - 03.6150C

#### Accessories

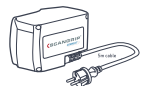

**POWER SUPPLY**  
03.6123C



**CAS BATTERY**  
18 V 5.2 Ah  
03.6121



**CAS CHARGER**  
03.6122

**3**  
years  
warranty

PATENT PROTECTED



## // Powerful illumination of the entire worksite

AREA 10 CONNECT provides a diffused and non-blinding work light with large dispersion. You can change between 360° and 180° illumination according to the work task and adjust the light output into five different levels by the built-in dimmer function. The compact design with a carrying handle makes AREA 10 CONNECT extremely handy and easy to move around. It is also supplied with a hook for flexible positioning and can be mounted directly on the SCANGRIP TRIPOD.

## // High flexibility and long operating time

AREA 10 CONNECT is compatible with METABO / CAS battery system 18 V and all other 18 V/20 V battery packs from leading power tool brands by using the SCANGRIP CONNECTOR. In addition, the POWER SUPPLY can be used for direct power providing unlimited availability to light. AREA 10 CONNECT also has an internal back-up battery securing 50 extra minutes at 1000 lumen.

## // BLUETOOTH light control

With the integrated BLUETOOTH light control it is possible to turn on/off the work light and adjust the light output through a mobile device, saving you time from manual operation and increasing work efficiency on a daily basis.

EU DESIGN  
PATENT  
213346



**Bluetooth®**

### BLUETOOTH - Light control app

- Dimmer light output into 5 levels 10 %-100 %
- Change between 360° and 180° illumination
- Switch on/off, check battery
- Group control function, up to 4 lamps
- Assign pin code

Compliant with iPhone 5 or higher / Android 5.0 or higher. Go to iTunes App Store to download the app or download the app from scangrip.com



### **Bluetooth** AREA 10 CONNECT

€ 299.90

03.6103C

360° work light with BLUETOOTH providing up to 10000 lumen



Hook for flexible positioning

### JUST CONNECT

Add the connector matching your 18 V/20 V battery pack



Use the SCANGRIP CONNECTOR to attach your 18 V/20 V battery pack to the AREA 10 CONNECT lamp

Use the POWER SUPPLY for direct power



Built-in powerbank

# AREA 6 CONNECT - 6000 lumen high efficiency 360° work light

// 360° high performance LED work light with powerful and diffused light for any kind of repair, paint or construction work.

- Powerful, diffused, non-blinding illumination
- 2 level light output (50 % -100 %)
- Compact and lightweight design

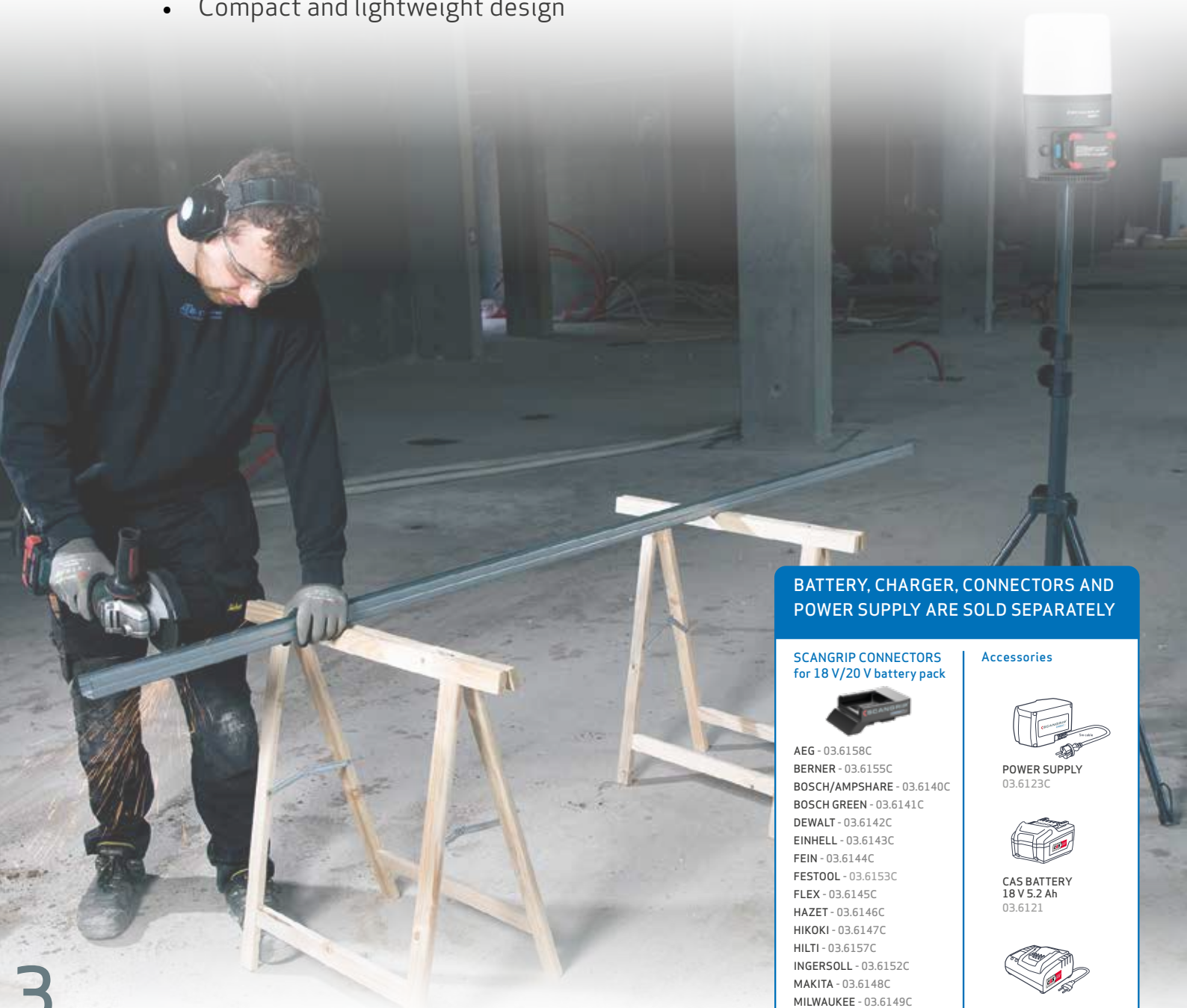

**BATTERY, CHARGER, CONNECTORS AND POWER SUPPLY ARE SOLD SEPARATELY**

#### SCANGRIP CONNECTORS for 18 V/20 V battery pack



AEG - 03.6158C  
BERNER - 03.6155C  
BOSCH/AMPSHARE - 03.6140C  
BOSCH GREEN - 03.6141C  
DEWALT - 03.6142C  
EINHELL - 03.6143C  
FEIN - 03.6144C  
FESTOOL - 03.6153C  
FLEX - 03.6145C  
HAZET - 03.6146C  
HIKOKI - 03.6147C  
HILTI - 03.6157C  
INGERSOLL - 03.6152C  
MAKITA - 03.6148C  
MILWAUKEE - 03.6149C  
PANASONIC - 03.6156C  
RIDGID - 03.6154C  
SNAP-ON - 03.6151C  
WÜRTH - 03.6150C

#### Accessories



**POWER SUPPLY**  
03.6123C



**CAS BATTERY**  
18 V 5.2 Ah  
03.6121



**CAS CHARGER**  
03.6122

**3**  
years  
warranty



## // Powerful 360° illumination of the working area

The AREA 6 CONNECT is a real basic work light providing a diffused and pleasant, non-blinding light up to 6000 lumen. It features 2 level light output (50 % - 100 %) which makes it possible to adjust the light according to the work task.

AREA 6 CONNECT is compatible with METABO / CAS battery system 18 V and all other 18 V/20 V battery packs from leading power tool brands by using the SCANGRIP CONNECTOR. In addition, the POWER SUPPLY can be used for direct power providing unlimited availability to light.

EU DESIGN  
PATENT  
4070035

## // Flexible positioning

Due to the compact and lightweight design, AREA 6 CONNECT is portable and easy to carry around. It is also supplied with a hook for flexible positioning and can be mounted directly on the SCANGRIP TRIPOD.



### AREA 6 CONNECT

**€ 179.90**

03.6108C

360° work light providing up to 6000 lumen



Use the SCANGRIP CONNECTOR to attach your 18 V/20 V battery pack to the AREA 6 CONNECT lamp



Use the POWER SUPPLY for direct power

NEW

# MULTILIGHT CONNECT

// New flexible concept of hand-held work light with multiple, exchangeable light heads.

- One handle for multiple light heads
- Flexible lamp head, rotates 120°
- New mounting system with snap hook, strap and magnet
- Compatible with METABO/CAS and all other 18 V/20 V battery packs



BATTERY, CHARGER, CONNECTORS AND POWER SUPPLY ARE SOLD SEPARATELY

#### SCANGRIP CONNECTORS for 18 V/20 V battery pack



AEG - 03.6158C  
BERNER - 03.6155C  
BOSCH/AMPSHARE - 03.6140C  
BOSCH GREEN - 03.6141C  
DEWALT - 03.6142C  
EINHELL - 03.6143C  
FEIN - 03.6144C  
FESTOOL - 03.6153C  
FLEX - 03.6145C  
HAZET - 03.6146C  
HIKOKI - 03.6147C  
HILTI - 03.6157C  
INGERSOLL - 03.6152C  
MAKITA - 03.6148C  
MILWAUKEE - 03.6149C  
PANASONIC - 03.6156C  
RIDGID - 03.6154C  
SNAP-ON - 03.6151C  
WÜRTH - 03.6150C

#### Accessories

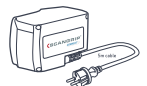

POWER SUPPLY  
03.6123C



CAS BATTERY  
18 V 5.2 Ah  
03.6121



CAS CHARGER  
03.6122

3  
years  
warranty

PATENT PROTECTED

## // Customisable lighting solutions

To ensure maximum functionality of the work light the body is equipped with a new invented, flexible mounting system. The system provides a combination of a strap, a hook, and a magnet in one unit. The strap is made of polyurethan which is both flexible, and durable with a smooth surface. By the snap hook at the end of the strap you can lock and fix the work light to any position. In the same way, the integrated magnet can be used to mount the work light body at any metallic surface available. The magnet is extremely powerful with a force strong enough to hold both body, light head, and battery.

The new high-performance MULTILIGHT CONNECT concept is based on the idea of combining a basic handle as known from power tools with a range of different work light heads which can be used and exchanged according to different applications.

MULTILIGHT CONNECT provides you with complete freedom to choose and tailor exactly the work light solution you need. Either you choose the MULTILIGHT BODY CONNECT handle and combine it with a selected light head, or you choose to acquire the body and more individual light heads to obtain a work light solution covering different purposes. Due to the flexible part of the body all light heads can be adjusted in an angle of 120°.



Built-in strap with snap hook and magnet for suspension



**NEW**

### MULTILIGHT BODY CONNECT

€ 54.90

03.5696C

Stand-alone handle to combine with selected CONNECT lamp heads



120°

### JUST CONNECT

Add the connector matching your 18 V/20 V battery pack



Use the POWER SUPPLY for direct power

Use the SCANGRIP CONNECTOR to attach your 18 V/20 V battery pack to the MULTILIGHT CONNECT BODY

**NEW**

### AREA HEAD CONNECT

€ 69.90

03.5701C

360° area light head providing up to 2500 Lumen

Lighting unit to be used with MULTILIGHT BODY CONNECT



**NEW**

### SEARCH HEAD CONNECT

€ 44.90

03.5699C

Extremely powerful search light head providing up to 600 lumen

Lighting unit to be used with MULTILIGHT BODY CONNECT



**NEW**

### FLEX HEAD CONNECT

€ 44.90

03.5697C

Slim, compact and extremely powerful inspection light head providing up to 750 lumen

Lighting unit to be used with MULTILIGHT BODY CONNECT



**NEW**

### FLOOD HEAD CONNECT

€ 49.90

03.5698C

Sturdy and extremely powerful floodlight head providing up to 1500 lumen

Lighting unit to be used with MULTILIGHT BODY CONNECT





NEW

# MULTILIGHT CONNECT

// The versatile system that can be purchased either as individual units or as ready-made sets.

ORIGINAL  
SCANGRIP  
SINCE 1906



## MULTILIGHT SEARCH CONNECT

€ 89.90

03.5695C

// Extremely powerful search light head providing up to 600 lumen

- Focus function zooming beam angle 10°-70°
- 2 lighting settings: 50 % - 100 %
- Long operating time, up to 24 h



Easy to mount and exchange light heads

3  
years  
warranty

PATENT PROTECTED



MULTILIGHT FLEX CONNECT

€ 89.90

03.5693C

// Slim, compact and extremely powerful inspection light head providing up to 750 lumen

- Rotates in all directions
- 2 light settings: 50 % - 100 %
- Long operating time, up to 26 h



MULTILIGHT FLOOD CONNECT

€ 94.90

03.5694C

// Sturdy and extremely powerful floodlight head providing up to 1500 lumen

- 2 light settings: 50 % - 100 %
- Long operating time, up to 13 h



360° flexibility

Rotates in all directions



# BASIC CONNECT - *Universal 1000 lumen compact floodlight*

// Small and compact universal floodlight with rotating lamp heads and two light settings.

- Basic floodlight for all purposes
- Lightweight and compact design
- Illumination with 1000 lumen
- Flexible lamp head



**BATTERY, CHARGER, CONNECTORS AND POWER SUPPLY ARE SOLD SEPARATELY**

#### SCANGRIP CONNECTORS for 18 V/20 V battery pack



AEG - 03.6158C  
BERNER - 03.6155C  
BOSCH/AMPSHARE - 03.6140C  
BOSCH GREEN - 03.6141C  
DEWALT - 03.6142C  
EINHELL - 03.6143C  
FEIN - 03.6144C  
FESTOOL - 03.6153C  
FLEX - 03.6145C  
HAZET - 03.6146C  
HIKOKI - 03.6147C  
HILTI - 03.6157C  
INGERSOLL - 03.6152C  
MAKITA - 03.6148C  
MILWAUKEE - 03.6149C  
PANASONIC - 03.6156C  
RIDGID - 03.6154C  
SNAP-ON - 03.6151C  
WÜRTH - 03.6150C

#### Accessories

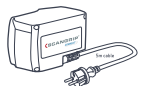

**POWER SUPPLY**  
03.6123C



**CAS BATTERY**  
18 V 5.2 Ah  
03.6121



**CAS CHARGER**  
03.6122

ORIGINAL  
SCANGRIP



SINCE 1906

**3**  
years  
warranty

PATENT PROTECTED



## // Universal floodlight for all needs

This new work light is the obvious choice if you need a minor, basic, and universal floodlight that can be used every-where for all purposes. BASIC CONNECT is compatible with METABO/CAS battery system 18 V and all other 18 V/20 V battery packs from leading power tool brands by using the SCANGRIP CONNECTOR. In addition, the SCANGRIP POWER SUPPLY can be used for direct power providing unlimited availability to light.

BASIC CONNECT provides as much as 1000 lumen and can be adjusted in 2 lighting settings, 50 % and 100 % depending on the actual job.

## // Flexible, rotating lamp head

The design of BASIC CONNECT is very compact, and lightweight, only 340 g without battery. BASIC CONNECT can be positioned on the surface where the battery base is acting as stand. Use the retractable metal hook for flexible suspension. The hook can be turned 360° for flexible positioning.

It is especially characteristic of the BASIC CONNECT that the lamp head has dual axis rotation. This means that the lamp head is 180° flexible from folded position. Furthermore, the lamp head can be rotated 180° sideways providing completely flexible positioning of the light.



Built-in hook for suspension



Flexible, rotating lamp head



### BASIC CONNECT

€ 59.90

03.6109C

Compact floodlight with flexible lamp head providing up to 1000 lumen

#### JUST CONNECT

Add the connector matching your 18 V/20 V battery pack



Use the SCANGRIP CONNECTOR to attach your 18 V/20 V battery pack to the BASIC CONNECT lamp



Use the POWER SUPPLY for direct power

# DUO & TOWER COMPACT CONNECT

// 2500 lumen floodlight with two lamp heads.

- High-efficiency in a compact design
- Adjustable light output 50 % and 100 %
- Multiple options for positioning
- Flexible lamp heads with dual axes rotation



BATTERY, CHARGER, CONNECTORS AND POWER SUPPLY ARE SOLD SEPARATELY

SCANGRIP CONNECTORS  
for 18 V/20 V battery pack



AEG - 03.6158C  
BERNER - 03.6155C  
BOSCH/AMPSHARE - 03.6140C  
BOSCH GREEN - 03.6141C  
DEWALT - 03.6142C  
EINHELL - 03.6143C  
FEIN - 03.6144C  
FESTOOL - 03.6153C  
FLEX - 03.6145C  
HAZET - 03.6146C  
HIKOKI - 03.6147C  
HILTI - 03.6157C  
INGERSÖLL - 03.6152C  
MAKITA - 03.6148C  
MILWAUKEE - 03.6149C  
PANASONIC - 03.6156C  
RIDGID - 03.6154C  
SNAP-ON - 03.6151C  
WÜRTH - 03.6150C

Accessories



POWER SUPPLY  
03.6123C



CAS BATTERY  
18 V 5.2 Ah  
03.6121



CAS CHARGER  
03.6122

3  
years  
warranty

PATENT PROTECTED

## // Extremely powerful work light

The new DUO CONNECT is a real “value-for-money” work light considering the extremely high level of lumen output, up to as much as 2500 lumen. The light output can be adjusted in 2 lighting settings, 50 % and 100 % depending on the actual job.

## // Multifunctional floodlight with two flexible lamp heads

With its two flexible lamp heads DUO CONNECT will be able to provide illumination from any lighting angle you need for the job. Both lamp heads have dual axis rotation which means that the lamp heads can be rotated in all directions independent of each other providing completely flexible positioning of the light source.

When folded the DUO CONNECT is very compact and streamlined.

DUO CONNECT can be positioned on the surface where the battery base is acting as stand. The foldable metal hook is for flexible suspension. For positioning in the height, DUO CONNECT is compatible with the 2 m SCANGRIP TRIPOD, item no. 03.5685.



Built-in hook for flexible suspension



Use as compact floodlight



### DUO CONNECT

€ 79.90

03.6111C

High-efficient floodlight with two flexible lamp heads providing 2500 lumen

**NEW**

## // Powerful floodlight with 2 m tripod with maximum flexibility

The floodlight provides extremely high level of lumen output, up to as much as 2500 lumen, and can be positioned directly on the tripod without any bracket or extra devices. This means that it can be dismantled as easily and positioned directly on the surface using the battery base as stand or positioned by the built-in hook.

Featuring 360° flexible and turnable lamp heads TOWER COMPACT CONNECT provides powerful illumination from any lighting angle you need for the job. Both lamp heads have dual axis rotation which means that the lamp heads can be rotated in all directions independent of each other providing completely flexible positioning of the light source. This provides perfect lighting condition for painting and installation work, for instance.

### TOWER COMPACT CONNECT

€ 169.90

03.6110C

Floodlight with two lamp heads providing 2500 lumen with tripod

Up to 2 m

0.78 m

Lightweight  
Easy to carry

**NEW**



With QUICK RELEASE function

### **JUST CONNECT**

Add the connector matching your 18 V/20 V battery pack



Use the SCANGRIP CONNECTOR to attach your 18 V/20 V battery pack



Use the POWER SUPPLY for direct power



# TOWER 5 CONNECT – 5000 lumen floodlight with integrated tripod

// Featuring two built-in floodlights, TOWER 5 CONNECT is ideal for the professional user who requires powerful and efficient illumination on the worksite.



- Integrated tripod with two built-in floodlights providing up to 5000 lumen
- 360° flexible and turnable floodlights
- QUICK-FOLD system
- Compact and lightweight design

BATTERY, CHARGER, CONNECTORS AND POWER SUPPLY ARE SOLD SEPARATELY

#### SCANGRIP CONNECTORS for 18 V/20 V battery pack



AEG - 03.6158C  
BERNER - 03.6155C  
BOSCH/AMPSHARE - 03.6140C  
BOSCH GREEN - 03.6141C  
DEWALT - 03.6142C  
EINHELL - 03.6143C  
FEIN - 03.6144C  
FESTOOL - 03.6153C  
FLEX - 03.6145C  
HAZET - 03.6146C  
HIKOKI - 03.6147C  
HILTI - 03.6157C  
INGERSOLL - 03.6152C  
MAKITA - 03.6148C  
MILWAUKEE - 03.6149C  
PANASONIC - 03.6156C  
RIDGID - 03.6154C  
SNAP-ON - 03.6151C  
WÜRTH - 03.6150C

#### Accessories

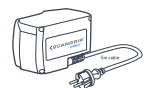

POWER SUPPLY  
03.6123C



CAS BATTERY  
18 V 5.2 Ah  
03.6121



CAS CHARGER  
03.6122

3  
years  
warranty

PATENT PROTECTED

## // High flexibility

Featuring 360° flexible and turnable floodlights, the lights can be positioned in any direction to obtain the desired lighting angle, providing perfect lighting condition for painting and installation work. TOWER 5 CONNECT is extendable up to 2 meters and features 2 level light output (50 % - 100 %) which makes it possible to adjust the light according to the work task.

TOWER 5 CONNECT is compatible with METABO/CAS battery system 18 V and all other 18 V/20 V battery packs from leading power tool brands by using the SCANGRIP CONNECTOR. In addition, the POWER SUPPLY can be used for direct power providing unlimited availability to light.



## // Slim design and lightweight

TOWER 5 CONNECT is the ideal mobile work light. Featuring a QUICK-FOLD system, it is fast to set up the tripod in only a few seconds and fold again when the job is done.

In folded position, the TOWER 5 CONNECT is compact and designed for one-hand transport with the integrated carrying handle. The sturdy, slim design and low weight of only 5.2 kg makes the TOWER 5 CONNECT tailored to bring around in the back of the car and convenient to carry around from one worksite to the other.



### TOWER 5 CONNECT

€ 249.90

03.6105C

Floodlight with built-in tripod providing up to 5000 lumen

#### JUST CONNECT

Add the connector matching your 18 V/20 V battery pack



Use the POWER SUPPLY for direct power



Use the SCANGRIP CONNECTOR to attach your 18 V/20 V battery pack to the TOWER 5 CONNECT lamp



# STANDS and SUSPENSIONS

// Designed for direct mounting of the NOVA CONNECT, AREA CONNECT and VEGA CONNECT work lights.

## // High stability tripod

The SCANGRIP TRIPOD is indispensable for stationary positioning of the work light for illumination in a specific working area. The SCANGRIP TRIPOD is extendable from only 1.35 m up to 3 m which gives you complete flexibility to position the light in the requested height.

The stable construction of the SCANGRIP TRIPOD 3M makes it safe even when fully extended. It is supplied with anchor points that provide an opportunity for extra stability if the tripod is exposed to strong wind or standing on an uneven surface. To increase safety when in use, the cable of the lamp can be fixed in the safety clips placed on each separate leg.

## // Lightweight TRIPOD with QUICK RELEASE function



With its lightweight and extremely handy design, the SCANGRIP TRIPOD 2M is indispensable for stationary positioning of the work light for illumination in a specific working area. The tripod is extendable from 0.9 meter up to 2 meters, which gives you complete flexibility to position the light in the requested height. When mounted on the tripod the light can be tilted to provide the optimum beam angle.

Featuring a compact design and QUICK RELEASE function, it is easy and convenient to carry the tripod and set it up where illumination is needed. The tripod is extremely durable and can be applied for both indoor and outdoor use. The stable construction makes it safe even when fully extended. It is made of black painted aluminum.

QUICK RELEASE function

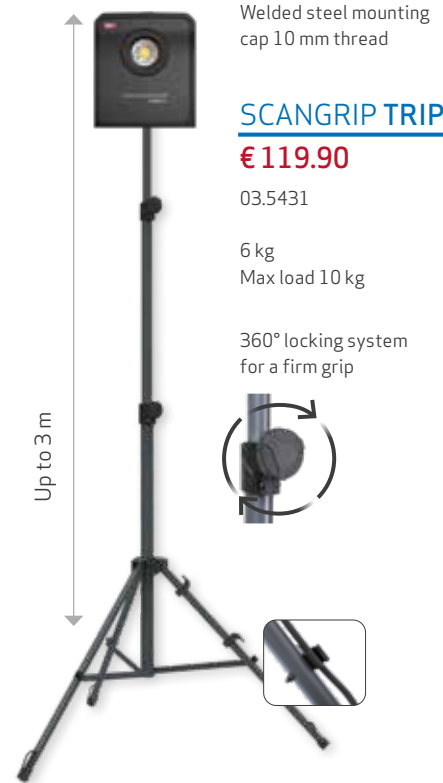

Welded steel mounting cap 10 mm thread

### SCANGRIP TRIPOD 3M

€ 119.90

03.5431

6 kg  
Max load 10 kg

360° locking system for a firm grip



**NEW**

### SCANGRIP TRIPOD 2M

€ 84.90

03.5685

2.1 kg  
Max load 5 kg

0.78 m  
Lightweight  
Easy to carry

DUAL BRACKET not applicable.

## // Wheel stand for mobile positioning

The SCANGRIP WHEEL STAND makes it easy to move the light to where you need it, and at the same time you avoid uncomfortable and heavy lifting from one workplace to the other. It is upgraded with a new base which is equipped with 5 wheels for improved safety and stability and easy maneuverability.

As an additional feature, it now comes with a flexible bracket that enables you to easily position a second work light to illuminate from below. The extra mounting bracket is adjustable in the height and provides complete flexibility to position the light in the optimum height.



### WHEEL STAND

**€ 159.90**

03.5682

6,6 kg  
Max load 10 kg

## // Suspensions for flexible positioning

### DUAL BRACKET

**€ 26.90**

03.5308



Dual bracket for positioning of two lamps on TRIPOD or WHEEL STAND

### SCAFFOLDING BRACKET

**€ 31.90**

03.5341



For flexible positioning on scaffoldings or any round object ø40-50 mm

### MAGNET BRACKET

**€ 31.90**

03.5390

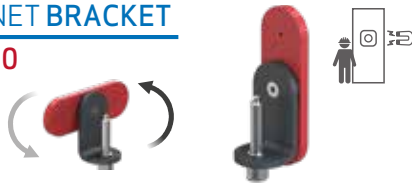

For flexible positioning of NOVA 4 CONNECT work light on any magnetic surface

### MAGNET BRACKET - Large

**€ 54.90**

03.5391



For flexible positioning of NOVA 10 CONNECT work light on any magnetic surface

## // SCANGRIP DIFFUSER provides a large dispersion and spreads the light

Enlightens the entire working area, even into the darkest corner and softens the light avoiding hard shadows. Minimizes reflections and harsh light and provides non-blinding work light.

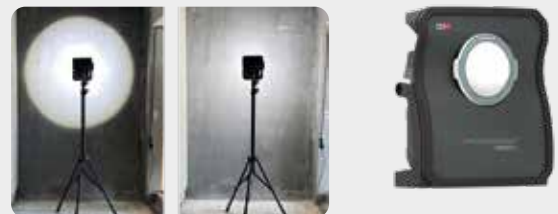

Easy and safe mounting with strong magnets

### SCANGRIP DIFFUSER

**€ 10.90**

03.5750

Fits NOVA 4 CONNECT



### SCANGRIP DIFFUSER - Large

**€ 15.90**

03.5751

Fits NOVA 10 CONNECT



### SCANGRIP DIFFUSER - Medium

**€ 8.90**

03.5922

Fits NOVA 2 CONNECT

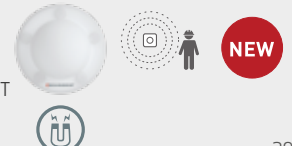





NOVA CONNECT series



	NOVA 2 CONNECT	NOVA 4 CONNECT	NOVA 10 CONNECT
Product number	03.6100C	03.6101C	03.6102C
Light source	High efficiency COB LED	High efficiency COB LED	High efficiency COB LED
LED performance, lumen/W	165	160	165
Luminous flux, lumen	200-2000	400-4000	1000-10000
Adjustable light output	5 levels	5 levels	5 levels
Beam angle	100°	110°	110°
CRI	Ra > 80	Ra > 80	Ra > 80
CCT	6000 K	6000 K	6000 K
Operating time with max. lumen, h	5.75@18 V 5.2 Ah battery	3@18 V 5.2 Ah battery	1.25@18 V 5.2 Ah battery
Operating time with min. lumen, h	58@18 V 5.2 Ah battery	31@18 V 5.2 Ah battery	12@18 V 5.2 Ah battery
Operating time: backup battery, h	-	2.5@10% / 400 lm	1@10% / 1000 lm
Battery	Compatible with METABO / CAS battery system 18 V and all other 18 V/20 V battery packs by using the SCANGRIP CONNECTOR	Compatible with METABO / CAS battery system 18 V and all other 18 V/20 V battery packs by using the SCANGRIP CONNECTOR	Compatible with METABO / CAS battery system 18 V and all other 18 V/20 V battery packs by using the SCANGRIP CONNECTOR
Protection class	IP30	IP65	IP65
Impact protection	IK07	IK07 with battery cover	IK07 with battery cover
Impact resistance	1 m	1 m	1 m
Charger input voltage	-	-	-
Power consumption	Max 16 W	Max 30 W	Max 75 W
Battery incl.	No	No	No
Charger incl.	No	No	No
Power supply Incl.	No	No	No
Temperature	-10 to +40 °C	-10 to +40 °C	-10 to +40 °C
Dimensions	161 x 164 x 78 mm	263 x 230 x 119 mm	304 x 292 x 131 mm
Net weight	720 g	2.36 kg	3.72 kg
Price	€ 99.90	€ 189.90	€ 299.90

## VEGA CONNECT series



	VEGA 2 CONNECT	VEGA 4 CONNECT
Product number	03.6106C	03.6104C
Light source	60 LEDs	105 LEDs
LED performance, lumen/W	189	189
Luminous flux, lumen	1000 / 2000 (step 1 / 2)	2000 / 4000 (step 1 / 2)
Adjustable light output	2 levels	2 levels
Beam angle	100°	100°
CRI	Ra > 80	Ra > 80
CCT	6000 K	6000 K
Operating time with max. lumen, h	4.5@18 V 5.2 Ah battery	2.25@18 V 5.2 Ah battery
Operating time with min. lumen, h	9@18 V 5.2 Ah battery	4.5@18 V 5.2 Ah battery
Operating time: backup battery, h	-	-
Battery	Compatible with METABO / CAS battery system 18 V and all other 18 V/20 V battery packs by using the SCANGRIP CONNECTOR	Compatible with METABO / CAS battery system 18 V and all other 18 V/20 V battery packs by using the SCANGRIP CONNECTOR
Protection class	IP54 with power supply IP30 with battery	IP54 with power supply IP30 with battery
Impact protection	IK06	IK07
Impact resistance	1 m	1 m
Charger input voltage	-	-
Power consumption	Max 20 W	Max 40 W
Battery incl.	No	No
Charger incl.	No	No
Power supply incl.	No	No
Temperature	-10 to +40 °C	-10 to +40 °C
Dimensions	200 x 208 x 78 mm	280 x 289 x 103 mm
Net weight	850 g	2.02 kg
Price	<b>€ 84.90</b>	<b>€ 134.90</b>



	AREA 10 CONNECT
Product number	03.6103C
Light source	240 LEDs
LED performance, lumen/W	189
Luminous flux, lumen	360°: 1000-10000 / 180°: 500-5000
Adjustable light output	5 levels
Beam angle	360° / 180°
CRI	Ra > 80
CCT	6000 K
Operating time with max. lumen, h	1@18 V 5.2 Ah battery
Operating time with min. lumen, h	22@18 V 5.2 Ah battery
Operating time: backup battery, h	50 min@10 % / 1000 lm
Battery	Compatible with METABO / CAS battery system 18 V and all other 18 V/20 V battery packs by using the SCANGRIP CONNECTOR
Protection class	IP65 IP54 with battery cover
Impact protection	IK07
Impact resistance	1 m
Charger input voltage	-
Power consumption	Max 84 W
Battery incl.	No
Charger incl.	No
Power supply incl.	No
Temperature	-10 to +40 °C
Dimensions	395 x 200 x 212 mm
Net weight	3.7 kg
Price	<b>€ 299.90</b>

	AREA 6 CONNECT
Product number	03.6108C
Light source	160 LEDs
LED performance, lumen/W	189
Luminous flux, lumen	3000 / 6000 (step 1 / 2)
Adjustable light output	2 levels
Beam angle	360°
CRI	Ra > 80
CCT	6000 K
Operating time with max. lumen, h	1.75@18 V 5.2 Ah battery
Operating time with min. lumen, h	6.5@18 V 5.2 Ah battery
Operating time: backup battery, h	-
Battery	Compatible with METABO / CAS battery system 18 V and all other 18 V/20 V battery packs by using the SCANGRIP CONNECTOR
Protection class	IP54 with power supply IP30 with battery
Impact protection	IK07
Impact resistance	1 m
Charger input voltage	-
Power consumption	Max 54 W
Battery incl.	No
Charger incl.	No
Power supply incl.	No
Temperature	-10 to +40 °C
Dimensions	ø195 x 363 mm
Net weight	1.97 kg
Price	<b>€ 179.90</b>

	BASIC CONNECT <b>NEW</b>
Product number	03.6109C
Light source	30 LEDs
LED performance, lumen/W	189
Luminous flux, lumen	500 / 1000 (step 1 / 2)
Adjustable light output	2 levels
Beam angle	110°
CRI	Ra > 80
CCT	6000 K
Operating time with max. lumen, h	9@18 V 5.2 Ah battery
Operating time with min. lumen, h	18@18 V 5.2 Ah battery
Operating time: backup battery, h	-
Battery	Compatible with METABO / CAS battery system 18 V and all other 18 V/20 V battery packs by using the SCANGRIP CONNECTOR
Protection class	IP30
Impact protection	IK07
Impact resistance	1 m
Charger input voltage	-
Power consumption	Max 10.5 W
Battery incl.	No
Charger incl.	No
Power supply incl.	No
Temperature	-10 to +40 °C
Dimensions	158 x 79 x 62 mm
Net weight	340 g
Price	<b>€ 59.90</b>

# MULTILIGHT CONNECT series



	MULTILIGHT SEARCH CONNECT <b>NEW</b>	MULTILIGHT FLEX CONNECT <b>NEW</b>	MULTILIGHT FLOOD CONNECT <b>NEW</b>
Product number	03.5695C	03.5693C	03.5694C
Light source	High power LED	High efficiency COB LED	High efficiency COB LED
LED performance, lumen/W	143	160	153
Luminous flux, lumen	300-600	375-750	750-1500
Adjustable light output	2 levels	2 levels	2 levels
Beam angle	10° - 70°	110°	110°
CRI	Ra > 70	Ra > 80	Ra > 80
CCT	6000 K	6000 K	6000 K
Operating time with max. lumen, h	12@18 V 5.2 Ah battery	12.5@18 V 5.2 Ah battery	6.5@18 V 5.2 Ah battery
Operating time with min. lumen, h	24@18 V 5.2 Ah battery	26@18 V 5.2 Ah battery	13@18 V 5.2 Ah battery
Battery	Compatible with METABO / CAS battery system 18 V and all other 18 V/20 V battery packs by using the SCANGRIP CONNECTOR	Compatible with METABO / CAS battery system 18 V and all other 18 V/20 V battery packs by using the SCANGRIP CONNECTOR	Compatible with METABO / CAS battery system 18 V and all other 18 V/20 V battery packs by using the SCANGRIP CONNECTOR
Protection class	IP30	IP30	IP30
Impact protection	IK07	IK07	IK07
Impact resistance	1 m	1 m	1 m
Charger input voltage	-	-	-
Power consumption	Max 8 W	Max 7.5 W	Max 14.5 W
Battery incl.	No	No	No
Charger incl.	No	No	No
Power supply Incl.	No	No	No
Max Load	-	-	-
Temperature	-10 to +40 °C	-10 to +40 °C	-10 to +40 °C
Dimensions	186 x 79 x 203 mm	168 x 79 x 203 mm	145 x 116 x 197 mm
Net weight	466 g	376 g	611 g
Price	<b>€ 89.90</b>	<b>€ 89.90</b>	<b>€ 94.90</b>



	SEARCH HEAD CONNECT <b>NEW</b>	FLEX HEAD CONNECT <b>NEW</b>	FLOOD HEAD CONNECT <b>NEW</b>	AREA HEAD CONNECT <b>NEW</b>
Product number	03.5699C	03.5697C	03.5698C	03.5701C
Light source	High power LED	High efficiency COB LED	High efficiency COB LED	60 LEDs
LED performance, lumen/W	143	160	153	189
Luminous flux, lumen	300-600	375-750	750-1500	1250-2500
Adjustable light output	2 levels	2 levels	2 levels	2 levels
Beam angle	10° - 70°	110°	110°	170° - 360°
CRI	Ra > 70	Ra > 80	Ra > 80	Ra > 80
CCT	6000 K	6000 K	6000 K	6000 K
Operating time with max. lumen, h	12@18 V 5.2 Ah battery	12.5@18 V 5.2 Ah battery	6.5@18 V 5.2 Ah battery	4.5@18 V 5.2 Ah battery
Operating time with min. lumen, h	24@18 V 5.2 Ah battery	26@18 V 5.2 Ah battery	13@18 V 5.2 Ah battery	9@18 V 5.2 Ah battery
Operating time: backup battery, h	-	-	-	-
Battery	Compatible with METABO / CAS battery system 18 V and all other 18 V/20 V battery packs by using the SCANGRIP CONNECTOR	Compatible with METABO / CAS battery system 18 V and all other 18 V/20 V battery packs by using the SCANGRIP CONNECTOR	Compatible with METABO / CAS battery system 18 V and all other 18 V/20 V battery packs by using the SCANGRIP CONNECTOR	Compatible with METABO / CAS battery system 18 V and all other 18 V/20 V battery packs by using the SCANGRIP CONNECTOR
Protection class	IP30	IP30	IP30	IP30
Impact protection	IK07	IK07	IK07	IK07
Impact resistance	1 m	1 m	1 m	1 m
Charger input voltage	-	-	-	-
Power consumption	Max 8 W	Max 7.5 W	Max 14.5 W	Max 22 W
Battery incl.	No	No	No	No
Charger incl.	No	No	No	No
Power supply Incl.	No	No	No	No
Max load	-	-	-	-
Temperature	-10 to +40 °C	-10 to +40 °C	-10 to +40 °C	-10 to +40 °C
Dimensions	92 x 49 x 49 mm	244 x 41 x 41 mm	57 x 116 x 106 mm	ø 110 x 173 mm
Net weight	195 g	105 g	340 g	506 g
Price	<b>€ 44.90</b>	<b>€ 44.90</b>	<b>€ 49.90</b>	<b>€ 69.90</b>



**MULTILIGHT BODY CONNECT** **NEW**

Product number	03.5696C
Light source	-
LED performance, lumen/W	-
Luminous flux, lumen	-
Adjustable light output	2 levels
Beam angle	-
CRI	-
CCT	-
Operating time with max. lumen, h	-
Operating time with min. lumen, h	-
Operating time: backup battery, h	-
Battery	Compatible with METABO / CAS battery system 18 V and all other 18 V/20 V battery packs by using the SCANGRIP CONNECTOR
Protection class	IP30
Impact protection	IK07
Impact resistance	1 m
Charger input voltage	-
Power consumption	-
Battery incl.	No
Charger incl.	No
Power supply incl.	No
Max load	90 W
Temperature	-10 to +40 °C
Dimensions	114 x 202 x 78 mm
Net weight	271 g
Price	<b>€ 54.90</b>



**MULTILIGHT CASE** **NEW**

	Product number	Price
<p>MULTILIGHT CASE For safe transport and storage of the MULTILIGHT range</p>	49.0511	<b>€ 59.90</b>

**DUO & TOWER CONNECT**



	<b>DUO CONNECT</b> <b>NEW</b>
Product number	03.6111C
Light source	2 x 40 LEDs
LED performance, lumen/W	189
Luminous flux, lumen	1250 / 2500 (step 1 / 2)
Adjustable light output	2 levels
Beam angle	180°
CRI	Ra > 80
CCT	6000 K
Operating time with max. lumen, h	4.5@18 V 5.2 Ah battery
Operating time with min. lumen, h	9.5@18 V 5.2 Ah battery
Operating time: backup battery, h	-
Battery	Compatible with METABO / CAS battery system 18 V and all other 18 V/20 V battery packs by using the SCANGRIP CONNECTOR
Protection class	IP30
Impact protection	IK07
Impact resistance	1 m
Charger input voltage	-
Power consumption	Max 19.5 W
Battery incl.	No
Charger incl.	No
Power supply incl.	No
Temperature	-10 to +40 °C
Dimensions	224 x 78 x 91 mm
Net weight	620 g
Price	<b>€ 79.90</b>



	<b>TOWER COMPACT CONNECT</b> <b>NEW</b>
Product number	03.6110C
Light source	2 x 40 LEDs
LED performance, lumen/W	189
Luminous flux, lumen	1250 / 2500 (step 1 / 2)
Adjustable light output	2 levels
Beam angle	180°
CRI	Ra > 80
CCT	6000 K
Operating time with max. lumen, h	4.5@18 V 5.2 Ah battery
Operating time with min. lumen, h	9.5@18 V 5.2 Ah battery
Operating time: backup battery, h	-
Battery	Compatible with METABO / CAS battery system 18 V and all other 18 V/20 V battery packs by using the SCANGRIP CONNECTOR
Protection class	IP30
Impact protection	IK07
Impact resistance	1 m
Charger input voltage	-
Power consumption	Max 19.5 W
Battery incl.	No
Charger incl.	No
Power supply incl.	No
Temperature	-10 to +40 °C
Dimensions	956 x 78 x 91 mm
Net weight	2.74 kg (incl. stand)
Price	<b>€ 169.90</b>



	<b>TOWER 5 CONNECT</b>
Product number	03.6105C
Light source	120 LEDs
LED performance, lumen/W	189
Luminous flux, lumen	2500 / 5000 (step 1 / 2)
Adjustable light output	2 levels
Beam angle	110°
CRI	Ra > 80
CCT	6000 K
Operating time with max. lumen, h	2@18 V 5.2 Ah battery
Operating time with min. lumen, h	4.5@18 V 5.2 Ah battery
Operating time: backup battery, h	-
Battery	Compatible with METABO / CAS battery system 18 V and all other 18 V/20 V battery packs by using the SCANGRIP CONNECTOR
Protection class	IP30
Impact protection	IK07
Impact resistance	1 m
Charger input voltage	-
Power consumption	Max 45 W
Battery incl.	No
Charger incl.	No
Power supply incl.	No
Temperature	-10 to +40 °C
Dimensions	121 x 153 x 892 mm
Net weight	5.2 kg
Price	<b>€ 249.90</b>



## CONNECTORS

SCANGRIP CONNECTORS for 18 V/20 V battery packs		Price
AEG	03.6158C	€ 9.90
BERNER	03.6155C	€ 9.90
BOSCH / AMPSHARE	03.6140C	€ 9.90
BOSCH GREEN	03.6141C	€ 9.90
DEWALT	03.6142C	€ 9.90
EINHELL	03.6143C	€ 9.90
FEIN	03.6144C	€ 9.90
FESTOOL	03.6153C	€ 9.90
FLEX	03.6145C	€ 9.90
HAZET	03.6146C	€ 9.90
HIKOKI	03.6147C	€ 9.90
HILTI*	03.6157C	€ 24.90
INGERSOLL	03.6152C	€ 9.90
MAKITA	03.6148C	€ 9.90
MILWAUKEE	03.6149C	€ 9.90
PANASONIC	03.6156C	€ 9.90
RIDGID	03.6154C	€ 9.90
SNAP-ON	03.6151C	€ 9.90
WÜRTH	03.6150C	€ 9.90

\*21.6 V



## BATTERY SAFETY SYSTEM

- Automatic discharge protection
- Overload protection
- Temperature surveillance
- Protected by design patent
- Approved by TÜV Rheinland



Scan QR code to see TÜV Rheinland test report

## Accessories



	CONNECT POWER SUPPLY	CAS BATTERY 18V Li-POWER 5.2 Ah	CAS BATTERY 18V Li-POWER 2.0 Ah	CAS CHARGER SC30
Product number	03.6123C	03.6121	03.6124	03.6122
Battery	-	18 V 5.2 Ah Li-power	18 V 2.0 Ah Li-power	-
Cable	5 m / 2 x 0.75 mm <sup>2</sup> H05RN-F	-	-	1.35 m / 2 x 0.75 mm <sup>2</sup> H03V VH2-F
Charger input voltage	100-240 V AC 50/60 Hz	-	-	220-240V AC 50/60 Hz
Output power	Max 90 W	-	-	Max 30 W
Charging time, h	-	208 min @100 % with CAS charger 03.6122	-	-
Protection class	IP65	IP20	IP20	IP20
Impact protection	IK07	-	-	-
Impact resistance	1 m	-	-	-
Temperature	-10 to +40 °C	-10 to +40 °C	-10 to +40 °C	0 to +40 °C
Dimensions	124 x 83 x 72 mm	121 x 81 x 66 mm	111 x 79 x 42 mm	152 x 142 x 76 mm
Net weight	1 kg	670 g	430 g	700 g
Compatibility	SCANGRIP CONNECT work lights	-	-	12V-18V CAS battery
Price	€ 79.90	€ 119.90	€ 59.90	€ 54.90

## SCANGRIP PRODUCT LINES



Specialized work lights for the painting industry



Explosion proof lights



Portable lights for fast curing



Lighting solutions for high performance



**3**  
years  
warranty

PATENT PROTECTED

Designed by us. Manufactured by us.



// SCANGRIP is Europe's leading manufacturer of work lights for professionals providing the strongest and most comprehensive ranges of work lights with the latest LED lighting technology available on the market.

SCANGRIP is innovation from Denmark and receives strong recognition in the marketplace for its product design, and the products are known for their high quality.

SCANGRIP strives for perfection, and is continuously optimizing and improving light output, battery capacity, design and ergonomics, durability, user-friendliness, and functionality. The aim is to set new standards for professional work lights.

SCANGRIP was established in 1906 and has a long, impressive history of manufacturing high-quality hand tools and work lights for the industrial, construction, and automotive sectors.

SCANGRIP is part of Hultafors Group - a global company offering a unique portfolio of premium brands within personal protection, tools, and other equipment for discerning craftsmen. Together, we are on a mission to create a better day for professional users.